

规格书 Specifications

WT-25@12-XXCOBL4-Y1



莹光系列
High penetration series



镜片材料 PMMA 8N温度-40°C~+70°C

透光率 400nm~900nm>90%

需要LF, 用温和的水和软布清洁镜片。

切勿在镜片上酒精及使用任何商业清洁剂。

请戴手套处理或安装镜片, 皮肤油脂可能会损坏镜片或其光学特性。

Lens material PMM working temperature:-40°C~+70°C

If necessary,Clean lenses with water or wet softcloth.

Never use any commercial cleaning solvents on lenses as alcohol.

When assembly, wearing gloves please,skin oils may damage lens or affect optial characteristic.

莹光系列 | High penetration series

WT-20@10-15COBL3-Y1	φ19.8×9.48mm	15°	WT-25@12-15COBL4-Y1	φ24.8×12.5mm	15°	WT-25@12-15COBL4-Y2	φ24.8×12.5mm	15°
WT-20@10-24COBL3-Y1	φ19.8×9.48mm	24°	WT-25@12-24COBL4-Y1	φ24.8×12.5mm	24°	WT-25@12-24COBL4-Y2	φ24.8×12.5mm	24°
WT-20@10-36COBL3-Y1	φ19.8×9.48mm	36°	WT-25@12-36COBL4-Y1	φ24.8×12.5mm	36°	WT-25@12-36COBL4-Y2	φ24.8×12.5mm	36°
WT-20@10-50COBL3-Y1	φ19.8×9.48mm	50°				WT-25@12-60COBL4-Y2	φ24.8×12.5mm	50°
WT-29@14-15COBL6-Y1	φ28.8×14.5mm	15°	WT-35@17-10COBL3-Y1	φ34.8×13.85mm	10°	WT-35@17-15COBL6-Y2	φ34.8×17.55mm	15°
WT-29@14-24COBL6-Y1	φ28.8×14.5mm	24°	WT-35@17-15COBL6-Y1	φ34.8×17.55mm	15°	WT-35@17-24COBL6-Y2	φ34.8×17.55mm	24°
WT-29@14-36COBL6-Y1	φ28.8×14.5mm	36°	WT-35@17-24COBL6-Y1	φ34.8×17.55mm	24°	WT-35@17-36COBL6-Y2	φ34.8×17.55mm	36°
WT-29@14-50COBL6-Y1	φ28.8×14.5mm	50°	WT-35@17-36COBL6-Y1	φ34.8×17.55mm	36°	WT-35@17-50COBL6-Y2	φ34.8×17.55mm	50°
			WT-35@17-60COBL6-Y1	φ34.8×17.55mm	50°			
WT-40@20-10COBL6-Y1	φ39.8×20mm	10°	WT-45@22-10COBL6-Y1	φ44.8×17.75mm	10°	WT-50@24-10COBL9-Y1	φ49.8×19.05mm	10°
WT-40@20-15COBL6-Y1	φ39.8×20mm	15°	WT-45@22-15COBL9-Y1	φ44.8×19.05mm	15°	WT-50@24-15COBL9-Y1	φ49.8×20.28mm	15°
WT-40@20-24COBL6-Y1	φ39.8×20mm	24°	WT-45@22-24COBL9-Y1	φ44.8×22.5mm	24°	WT-50@24-24COBL9-Y1	φ49.8×23.85mm	24°
WT-40@20-36COBL6-Y1	φ39.8×20mm	36°	WT-45@22-36COBL9-Y1	φ44.8×22.5mm	36°	WT-50@24-36COBL9-Y1	φ49.8×23.85mm	36°
WT-40@20-50COBL6-Y1	φ39.8×20mm	50°	WT-45@22-50COBL9-Y1	φ44.8×22.5mm	50°	WT-50@24-50COBL9-Y1	φ49.8×23.85mm	50°
WT-55@26-15COBL11-Y1	φ54.8×26.25mm	15°	WT-62@30-15COBL11-Y1	φ61.8×29.6mm	15°	WT-68@33-15COBL11-Y1	φ67.8×32.5mm	15°
WT-55@26-24COBL11-Y1	φ54.8×26.25mm	24°	WT-62@30-24COBL11-Y1	φ61.8×29.6mm	24°	WT-68@33-24COBL11-Y1	φ67.8×32.5mm	24°
WT-55@26-36COBL11-Y1	φ54.8×26.25mm	36°	WT-62@30-36COBL11-Y1	φ61.8×29.6mm	36°	WT-68@33-36COBL11-Y1	φ67.8×32.5mm	36°
WT-55@26-50COBL11-Y1	φ54.8×26.25mm	50°	WT-62@30-50COBL11-Y1	φ61.8×29.6mm	50°	WT-68@33-50COBL11-Y1	φ67.8×32.5mm	50°
WT-75@36-15COBL14-Y1	φ74.8×35.8mm	15°						
WT-75@36-24COBL14-Y1	φ74.8×35.8mm	24°						
WT-75@36-36COBL14-Y1	φ74.8×35.8mm	36°						
WT-75@36-50COBL14-Y1	φ74.8×35.8mm	50°						

技术参数 | Specifications



型号 Code	发光面 light-emitting surface	角度 FWHM	尺寸 Size(L*W*H)mm	标准效率 Typ.eff	材质 Material
WT-25@12-15COBL4-Y1	φ3/φ4mm COB	15°	φ24.8×12.5	93%	PMMA
WT-25@12-24COBL4-Y1	φ4mm COB	24°		93%	PMMA
WT-25@12-36COBL4-Y1	φ4mm COB	36°		93%	PMMA

产品配件 | Product accessories



碗杯 (PC)	Lens Holder (PC)	WT-F25H-B	D 25.3, H 9.4 mm
---------	------------------	-----------	------------------



支架 (PC)	COB Holder (PC)	WT-F25H-C125/C135 WT-F25HB-C135	D 21, H 3.9 mm
---------	-----------------	------------------------------------	----------------

产品尺寸 | Dimensions(Unit:mm)

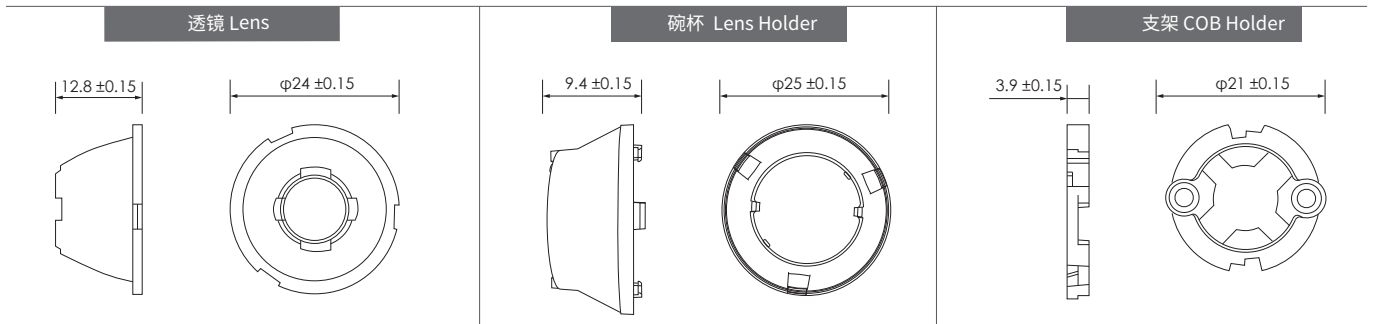

Shenzhen Wisertop Technology Co.,Ltd				PART NO.: WT-25@12-XXCOBL4-YX		NAME: LED LENS	
TOLERANCE UNLESS OTHERWISE MARKED DIMENSION: ANGULAR 0~6:±0.05 0.2 6~30:±0.10 30~120:±0.15				MATERIAL: PMMA		SPEC:	
				APPR OVED	CHECK ED	DRAW BY	REV: A01
A3	UNIT: mm	SCALE: 1:1	SHEET 1OF1				

线性	等级	F	M	C	
0-3		±0.05	±0.1	±0.2	— 直线度
>3-6		±0.05	±0.1	±0.2	▭ 平面度
>6-16		±0.1	±0.15	±0.3	○ 圆度
>16-30		±0.1	±0.2	±0.5	∅ 圆柱度
>30-120		±0.15	±0.3	±0.8	∩ 线轮廓度
>120-315		±0.2	±0.5	±1.2	∪ 面轮廓度
>315-1000		±0.5	±0.8	±2.0	// 平行度
>1000-2000		±1.0	±1.2	±3.0	⊥ 垂直度
角度		±60°			≡ 对称度
					◎ 同轴度

装箱尺寸 | Packing (Unit:mm)

透镜 Lens	
产品尺寸Single Size(L*W*H)	φ24×12.5
包装尺寸Box Size(L*W*H)	150x230x380
外箱尺寸CTN Size(L*W*H)	390x245x395
装箱数量PCS/CTN	1620pcs

注：透镜使用吸塑托盘包装

灯杯 Holder	
产品尺寸Single Size(L*W*H)	φ25×9.4
包装尺寸Box Size(L*W*H)	300x200
外箱尺寸CTN Size(L*W*H)	/
装箱数量PCS/CTN	2500pcs

注：灯杯使用袋装

支架 PTape	
产品尺寸Single Size(L*W*H)	φ21×3.9
包装尺寸Box Size(L*W*H)	300x200
外箱尺寸CTN Size(L*W*H)	/
装箱数量PCS/CTN	7200pcs

注：支架使用袋装

配光曲线 | Luminance Diatribution Diagram



WT-25@12-24COBL4-Y1

LED	CXM-4
FWHM	23.9°
FWTM	35.4°
Peak intensity	5.823 cd /lm
Efficiency	93 %
Aluminum substrate size	12.5×12.5

Average Beam Angle (50%):23.9°
Radiation Intensity (Unit: cd)

— C0·C180 23.9°
— C90·C270 23.9°

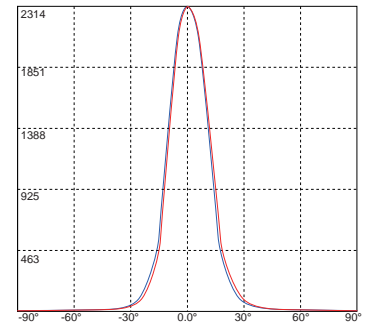
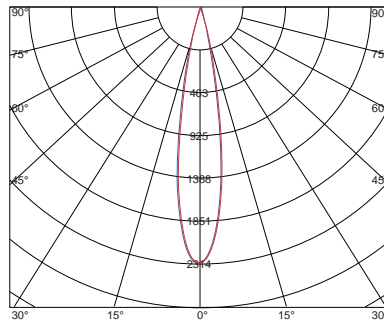

WT-25@12-24COBL4-Y1

LED	V4HD
FWHM	24.2°
FWTM	36.3°
Peak intensity	6.74 cd /lm
Efficiency	93 %
Aluminum substrate size	12.5×12.5

Average Beam Angle (50%):24.2°
Radiation Intensity (Unit: cd)

— C0·C180 24.2°
— C90·C270 24.2°

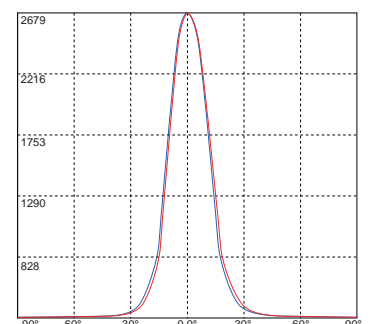
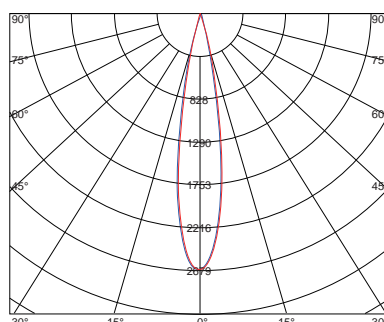



WT-25@12-24COBL4-Y1

LED	P4
FWHM	24.6°
FWTM	23.6°
Peak intensity	6.21 cd /lm
Efficiency	93 %
Aluminum substrate size	12.5×12.5

Average Beam Angle (50%):24.6°
Radiation Intensity (Unit: cd)

— C0 · C180 24.6°
— C90 · C270 24.6°

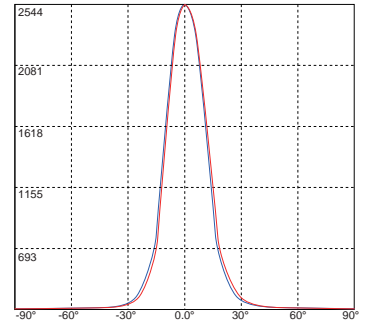
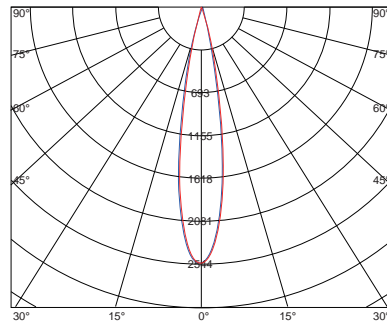

WT-25@12-36COBL4-Y1

LED	CXM-4
FWHM	35.2°
FWTM	46.7°
Peak intensity	3.61 cd /lm
Efficiency	93 %
Aluminum substrate size	12.5×12.5

Average Beam Angle (50%):35.2°
Radiation Intensity (Unit: cd)

— C0 · C180 35.2°
— C90 · C270 35.2°

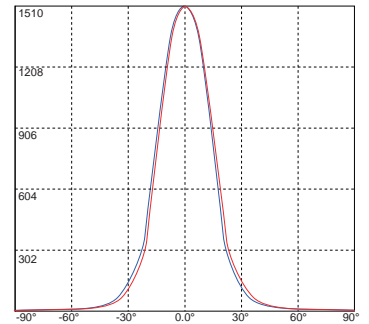
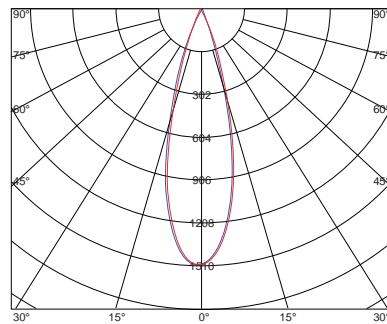

WT-25@12-36COBL4-Y1

LED	V4HD
FWHM	36.4°
FWTM	47.9°
Peak intensity	4.32 cd /lm
Efficiency	93 %
Aluminum substrate size	12.5×12.5

Average Beam Angle (50%):36.4°
Radiation Intensity (Unit: cd)

— C0 · C180 36.4°
— C90 · C270 36.4°

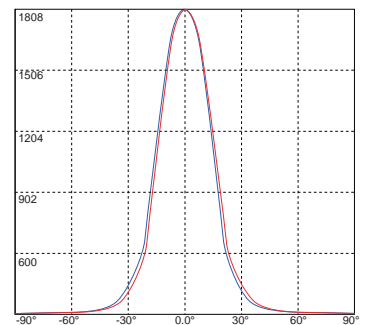
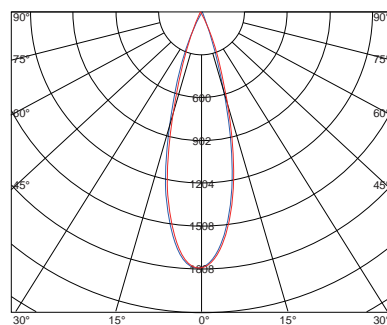



LED	P4
FWHM	36.8°
FWTM	48.3°
Peak intensity	4.13 cd /lm
Efficiency	93 %
Aluminum substrate size	12.5×12.5

Average Beam Angle (50%):36.8°
 Radiation Intensity (Unit: cd)

— C0 · C180 36.8°
 — C90 · C270 36.8°

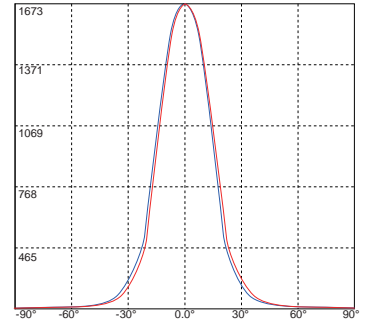
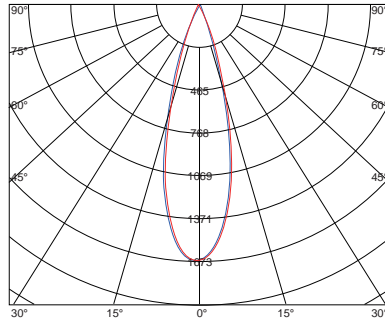

产品声明

所有数据提供在我们的数据表, 机械图纸和所有其他可下载的文件在我们的网站 www.wisertop.cn 有可能随时更改, 恕不另行通知. WISERTOP 不保证除在自己的网站上任何文件. 因此, 所有的客户, 在分销商、合作伙伴或其他第三方网站或移动应用程序上可下载的文件不受 wisertop 的保证, 我们文件中提供的所有数据都是基于我们自己的测量和评估, 并在我们的实验室内部或经认证的第三方实验室进行的. 所有数据, 甚至是模拟数据; 仅供参考和设计之用. 所有数据可能随时更改, 如果 WISERTOP. 改进其产品 / 服务或改进其实验室设备. 我们不负责所有的使用条件, 在某些使用条件下超出材料规格 (PMMA, PCSilicone, 我们产品中使用的任何其他材料) 不承担任何责任.

RELIABILITY

WISERTOP All data provided in our datasheets, mechanical drawing and all other downloadable documents on our website www.wisertop.com are subject to change at any time without prior notice WISERTOP. do not guarantee any of its own document nowhere else than on its own websites. As a consequence, all WISERTOP. documents that are downloadable on distributors, partners or other third-party websites or mobile applications are NOT guaranteed by WISERTOP. All data provided in our documents are based on our own measurements and evaluation and performed in-house in our optical laboratory, or in a certified third-party laboratory. Also, all data, even simulated data, are provided for reference and design purpose only. All data may change at any time if WISERTOP. improves its products/services or improves its own laboratory equipment. CACCIONE S.A.S. is not responsible for the final use conditions and takes no responsibility under certain use conditions, out of the material specification (PMMA, PCSilicone, any other material used in our products).

WISER^{TOP}
Wisertop · Magician Of Light

深圳市智宏通科技有限公司
Shenzhen Wisertop Technology Co., Ltd

地址: 深圳市光明区玉塘街道田寮第六工业园6栋

Add: NO.3 6 Building, Tianliao Sixth Industrial Park Yutang street, Guangming District, Shenzhen

Fax: +86 755 28322671

SKype: lselie.h

Phone: +86 755 89219321

E-mail: sale02@wisertop.cn



<http://www.wisertop.cn>